

140

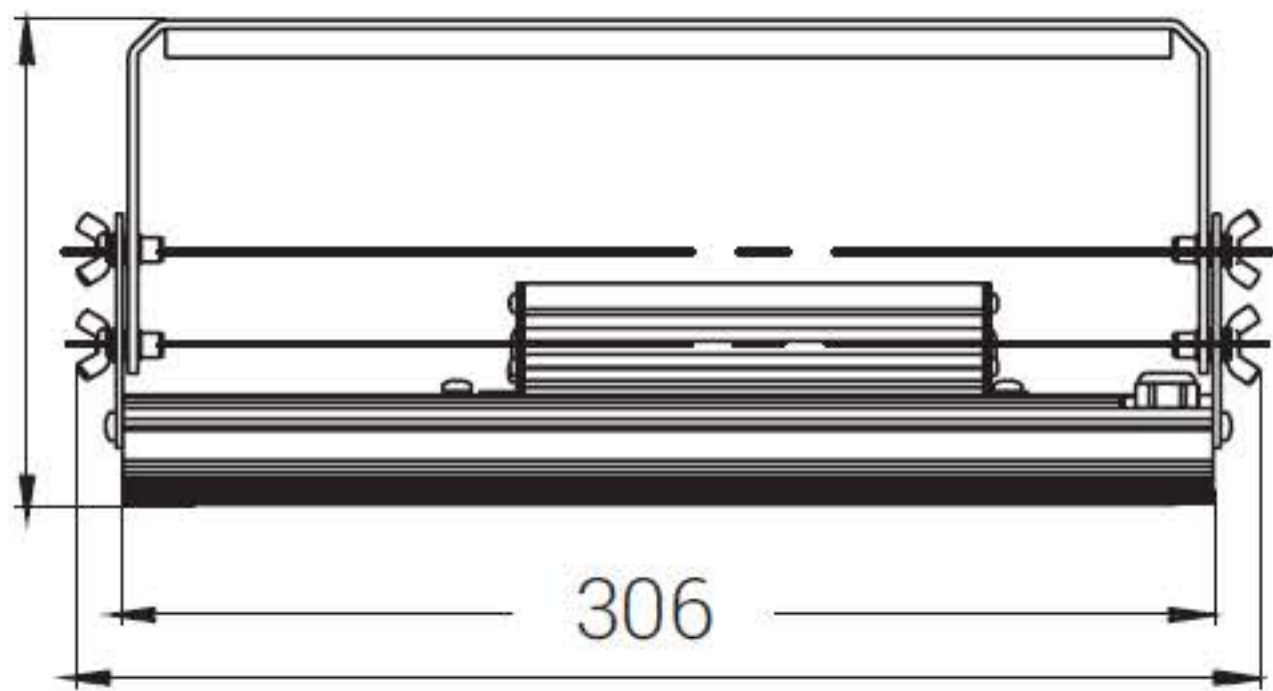

306

332

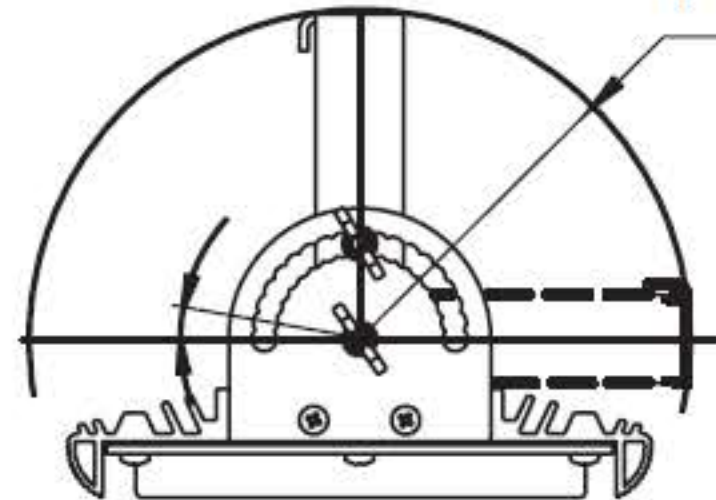

R95

165

